



CENTURY

LIGHTING | ART | DESIGN

joekrauslighting

301-537-5808

joe@joekrauslighting.com

www.joekrauslighting.com







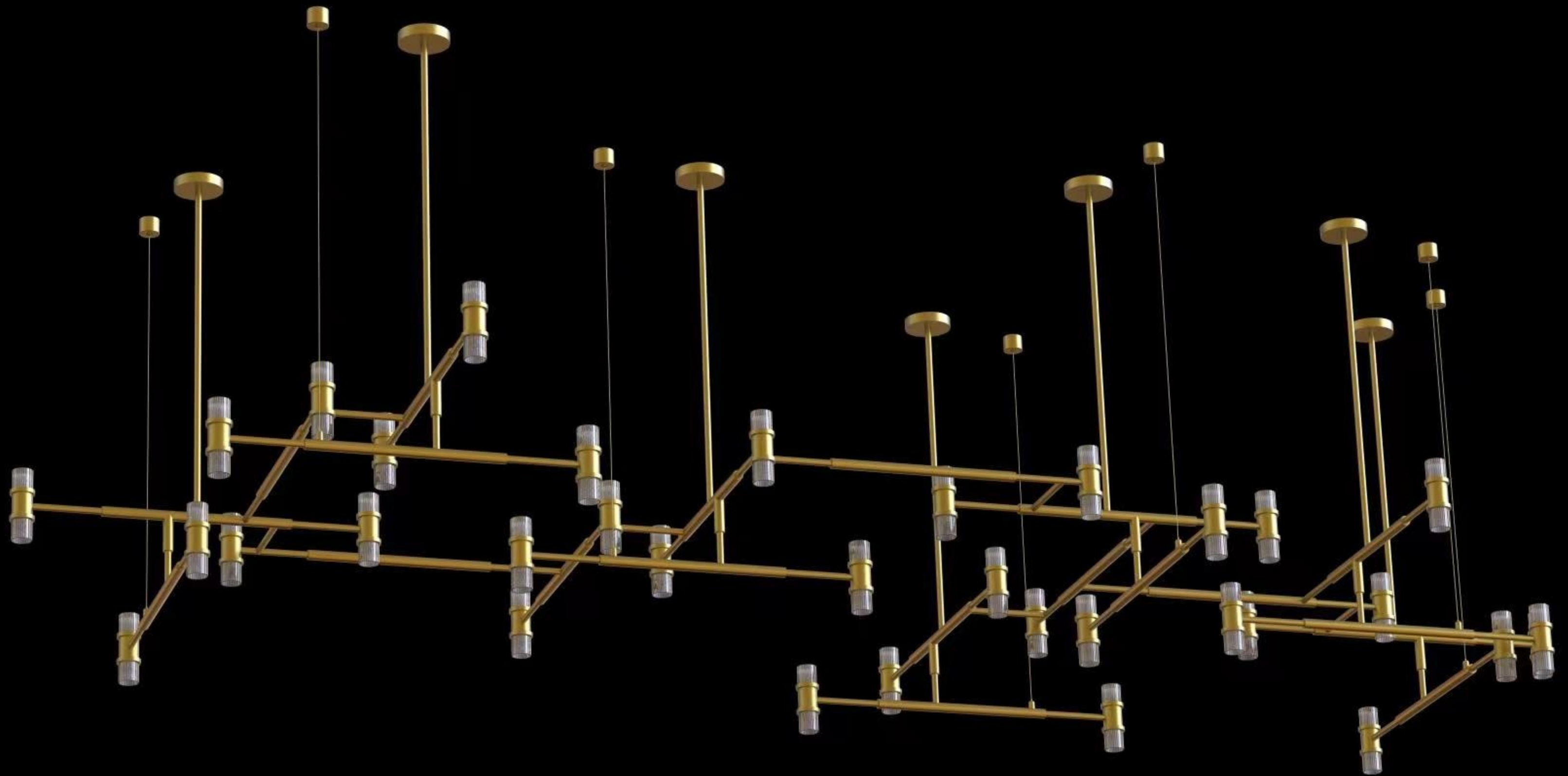

NOTES:

- 1)METAL: ALL EXPOSED METAL FINISH TO BE SATIN GOLD BRONZE PLATED
 - 2)SHADE: RIBBED CLEAR GLASS TUBES.
 - 3)LAMPING: INTEGRATED LED 170W 2700K.DIMMABLE. W/REMOTE DRIVERS. 120V.A.C. 60Hz
 - 4)HARD WIRED. ON-SITE ASSEMBLY REQUIRED
- UL/CUL APPROVED
 ***APPROX MAX. WEIGHTS: 620LBS

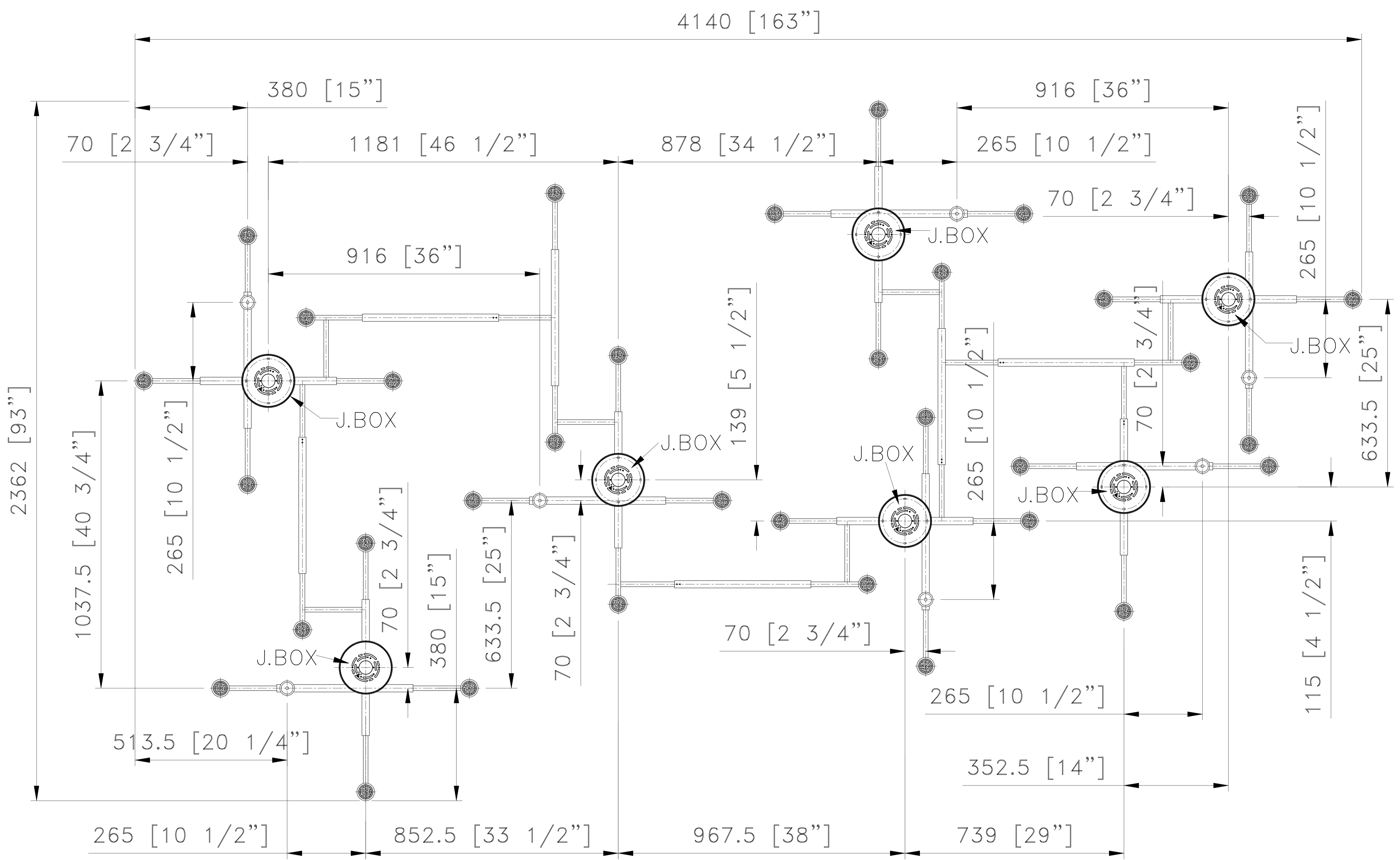

MAIN DINING LIGHT FIXTURE

ITEM NO:220-LF-1 QTY:8PCS

CAE, NEW ORLEANS

PROJECT:3662

Approval: Date: _____

With comments: _____

Signed By: _____

Estimated Leads time are contingent upon receiving approved submittals and are subject to change

Les Industries CENTURY Industries Inc.

5645 Royalmount Ave.

Montreal, Quebec, Canada H4P 2P9

Tel:514-842-3933 Fax:514-842-7481

Toll free Canada only:1-877-842-3934

Date:2023/04/05 Rev: _____

(yyyy/mm/dd)

(yyyy/mm/dd)

Dwg. #

NOTES:

- 1)METAL: ALL EXPOSED METAL FINISH TO BE SATIN GOLD BRONZE PLATED
 - 2)SHADE: RIBBED CLEAR GLASS TUBES.
 - 3)LAMPING: INTEGRATED LED 170W 2700K.DIMMABLE. W/REMOTE DRIVERS. 120V.A.C. 60Hz
 - 4)HARD WIRED. ON-SITE ASSEMBLY REQUIRED
- UL/CUL APPROVED
 ***APPROX MAX. WEIGHTS: 1050LBS

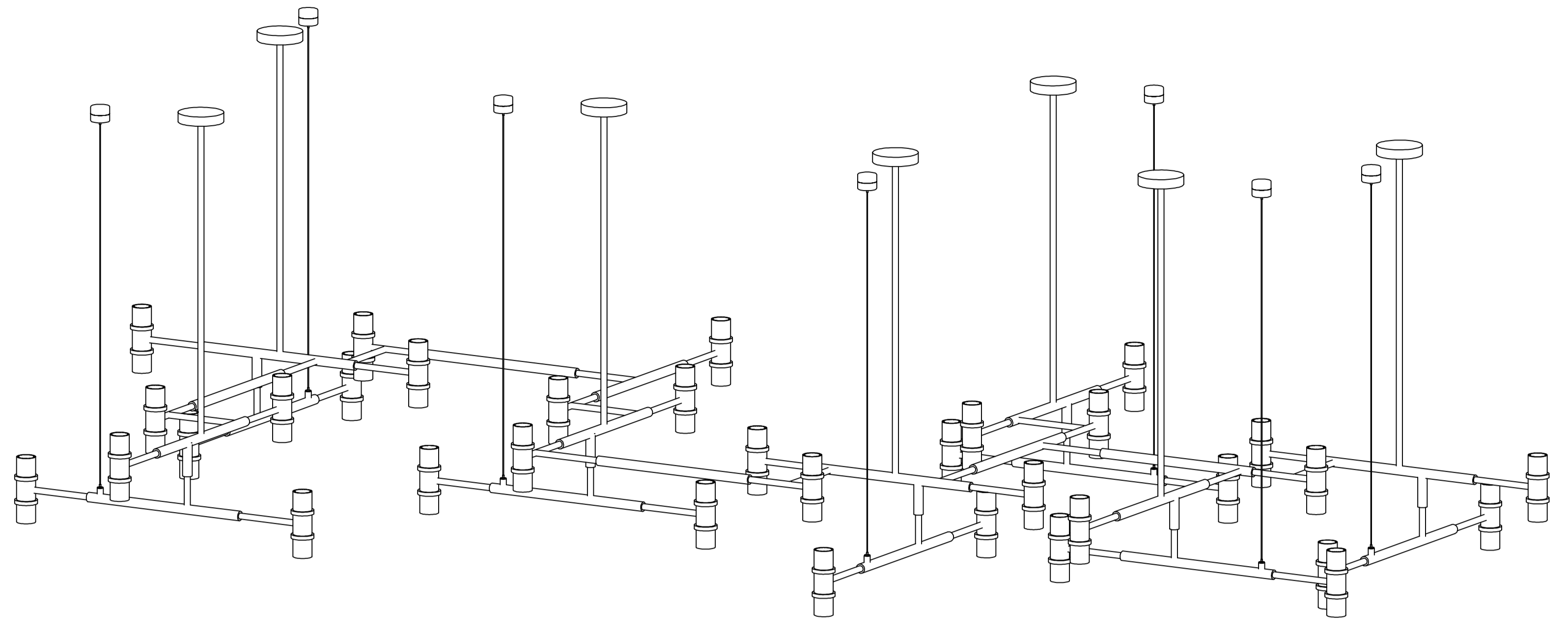
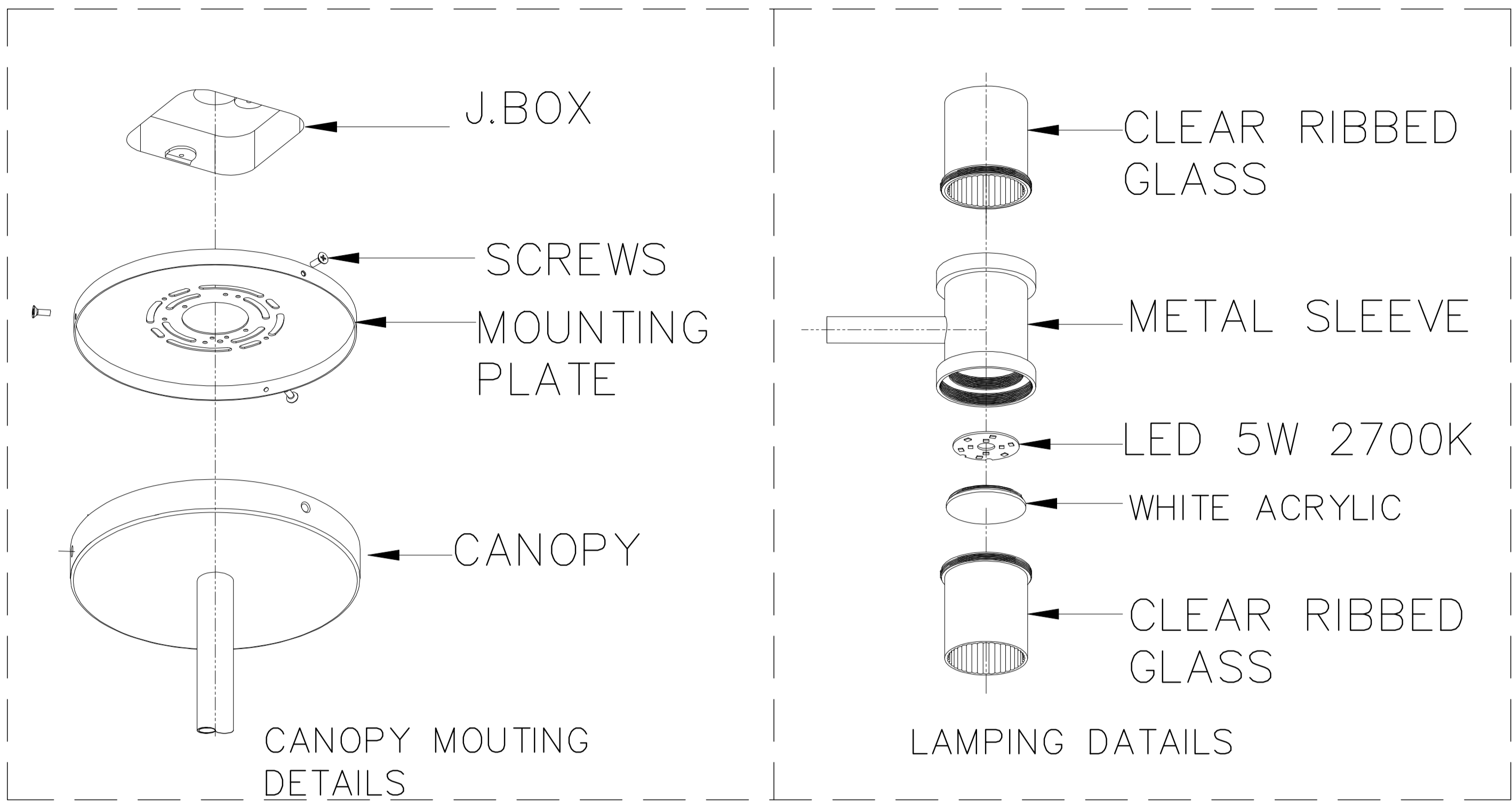

3D VIEW

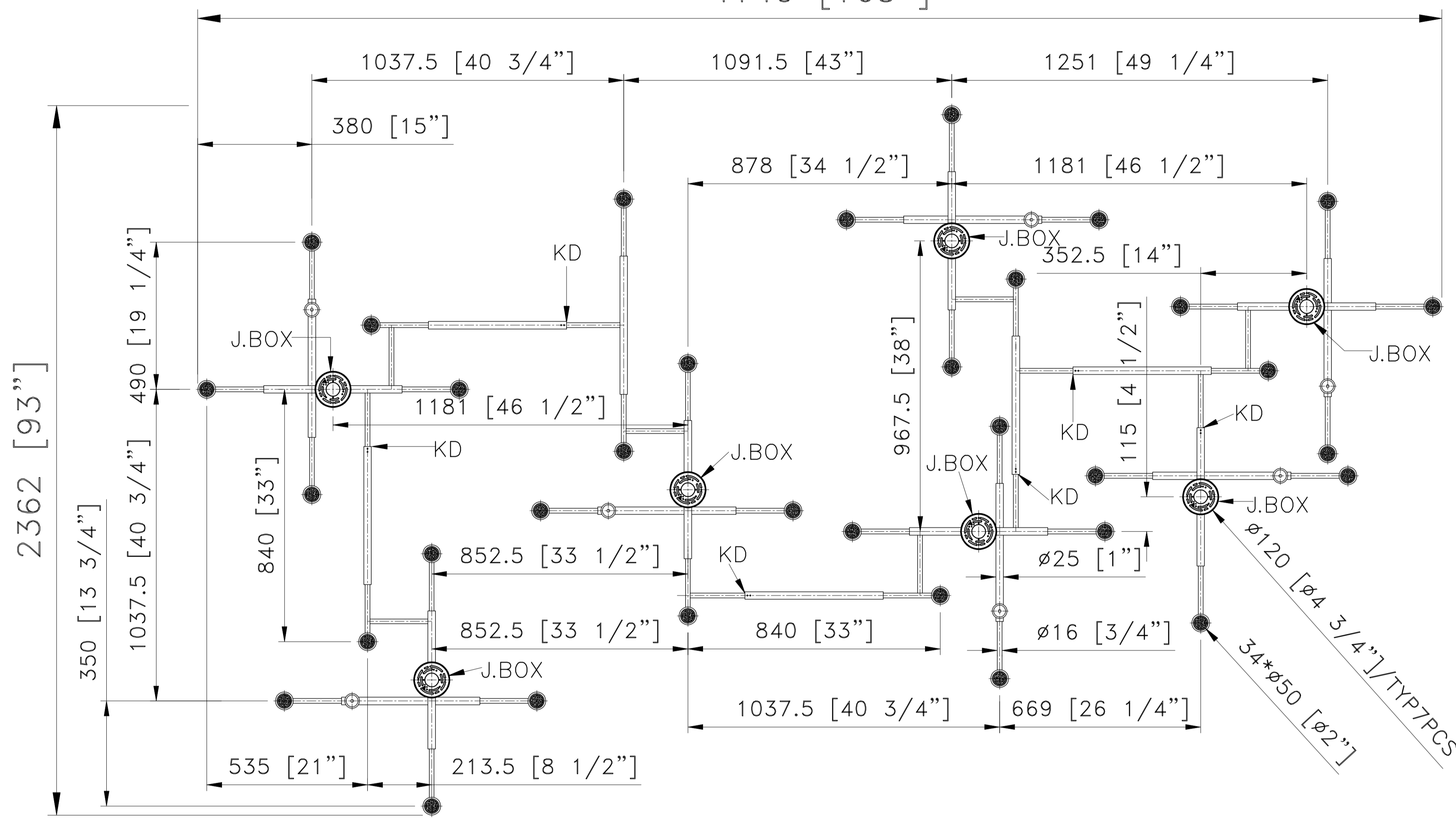

TOP VIEW

SCALE: 1 : 40

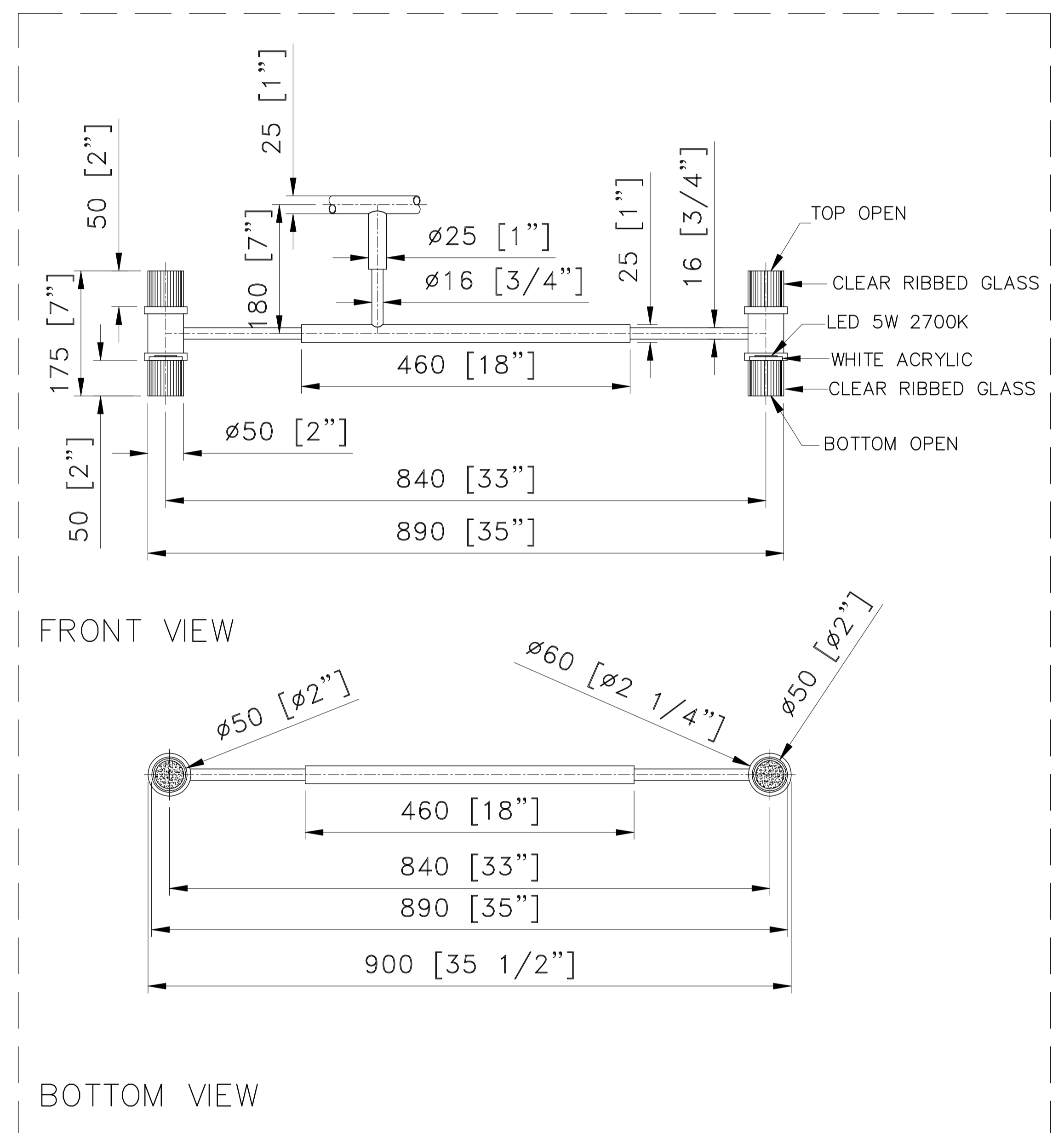

FRONT VIEW

BOTTOM VIEW

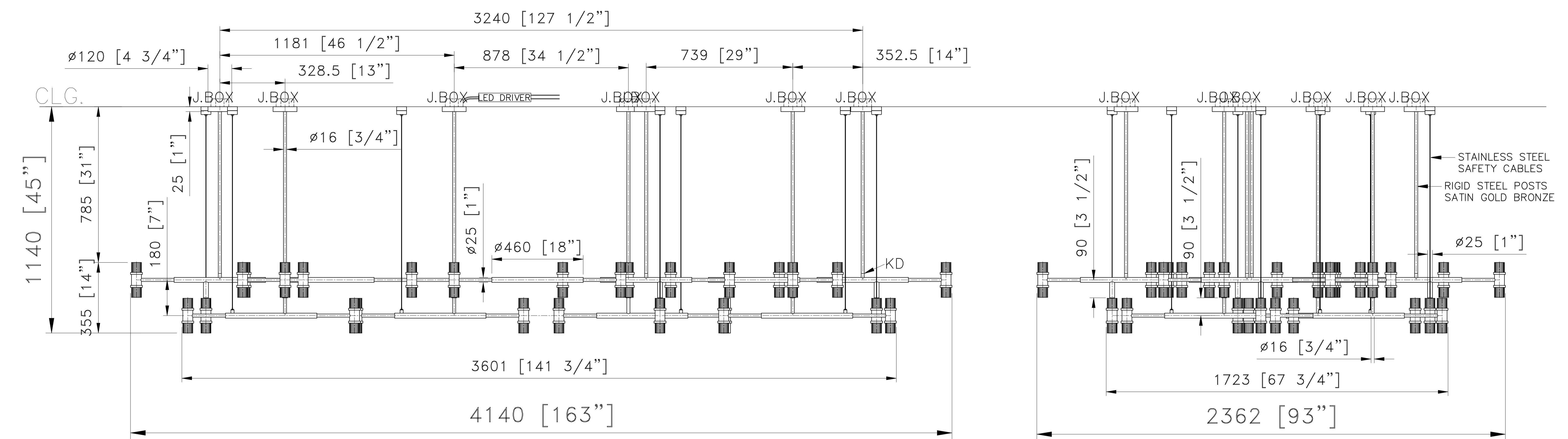

FRONT VIEW

SCALE: 1 : 40

SIDE VIEW

SCALE: 1 : 40

MAIN DINING LIGHT FIXTURE

ITEM NO:220-LF-1 QTY:8PCS

CAE, NEW ORLEANS

PROJECT:3662

Approval: Date: _____

With comments: _____

Signed By: _____

Estimated Leads time are contingent upon receiving approved submittals and are subject to change

Les Industries CENTURY Industries Inc.

5645 Royalmount Ave.

Montreal, Quebec, Canada H4P 2P9

Tel:514-842-3933 Fax:514-842-7481

Toll free Canada only:1-877-842-3934

Date:2023/02/04 Rev:2023/03/16

(yyyy/mm/dd)

(yyyy/mm/dd)

Dwg. #